

## FEATURES:

- 1X1 Tab-UP, 1" Long RJ45 with internal magnetics
- 12pin signal pin versions available
- Available with and without LEDs
- Suitable for CAT 5 & 6 Fast Ethernet Cable or better UTP
- Internal magnetics are 100% electrically tested for HI-POT and functionality
- 350  $\mu$ H minimum OCL with 8 mA bias current
- Meets IEEE 802.3 specification



YUAN DEAN SCIENTIFIC



RJ45 Jack  
56F SERIES

With Magnetics

10/100/1000 Base-T

TAB Up



ELECTRICAL SPECIFICATIONS@25°C  
Operating temperature 0°C TO 70°C

Part Number	Turns Ratio (±5%)	LEDs	Insertion Loss (dB MAX)		Return Loss (dB TYP) 100Ω±15Ω			Crosstalk (dB TYP)			Common Mode Rejection (dB TYP)		Hipot (Vrms)
		L/R	1-100 MHz	1-10 MHz	30 MHz	60-80 MHz	80-100 MHz	1-10 MHz	32-65 MHz	65-100 MHz	1-125 MHz	125-500 MHz	@60Hz
56F-1301GYD2NL	1CT:1CT	G/Y	-1.0	-20	-16	-12	-10	-40	-35	-30	-30	-20	1500



Mechanical and Dimension

LED

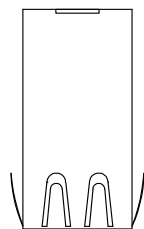

YY:Year WW:Week

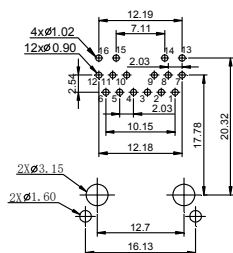

PC Board Layout Component Side Shown

NO LED

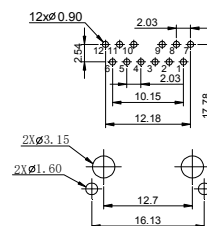
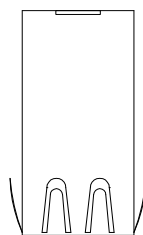

PC Board Layout Component Side Shown

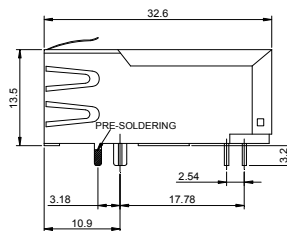
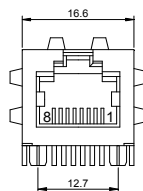
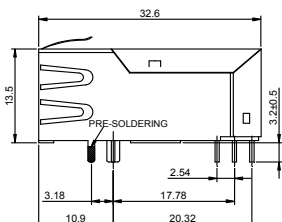
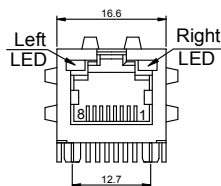

Schematics

56F-1301

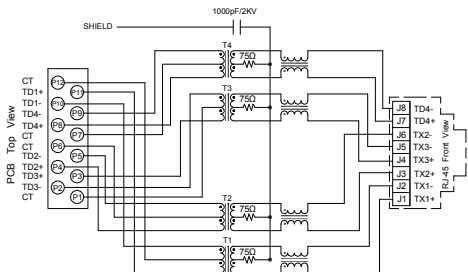

56F-1302

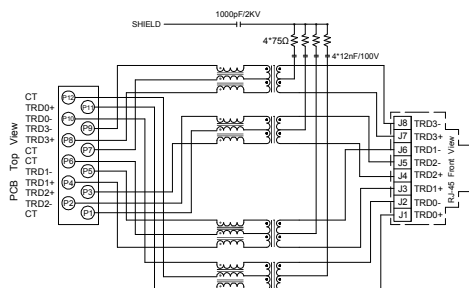

56F-1304

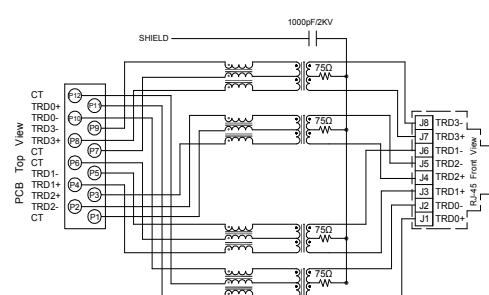

56F-1401

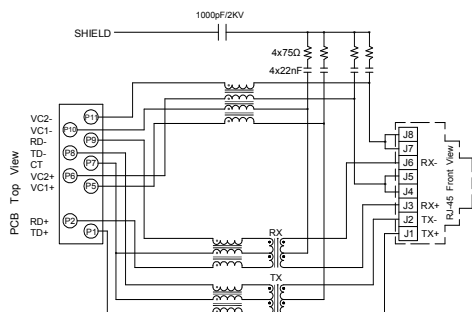

56F-1402

